



Safety Instructions

Read this manual carefully before use, and retain it for future reference.

This product is for floor cleaning in a home environment only. Do not use it outdoors, on non-floor surfaces, or in a commercial or industrial setting.

Usage Restrictions

- This appliance can be used by children aged from 8 years and above and persons with reduced physical, sensory or mental capabilities or lack of experience and knowledge if they have been given supervision or instruction concerning use of the appliance in a safe way and understand the hazards involved. Children shall not play with the appliance. Cleaning and user maintenance shall not be made by children without supervision.
- This appliance contains batteries that are only replaceable by skilled persons.
- Please keep the cleaning brush out of reach of children.
- Keep hair, loose clothing, fingers, and all parts of body away from openings and moving parts.
- Do not use the robot vacuum to clean any burning substances.
- Make sure the robot vacuum is turned off and the power supply is unplugged before cleaning or performing maintenance.

- This robot vacuum is only intended to clean floors in a home environment. Do not use it outdoors such as on an open balcony or on a surface that is not a floor, like a sofa, or in a commercial or industrial setting.
- Do not use the robot vacuum in an area suspended above ground level, such as a loft, open balcony, or on top of furniture, unless a protective barrier is present.
- Do not use the robot vacuum at an ambient temperature above 35°C or below 0°C or on a floor with liquids or sticky substances.
- Pick up any cables from the floor before using the robot vacuum to prevent it from dragging them while cleaning. A hazard may occur if the appliance runs over the supply cord.
- Pick up any fragile or loose items from the floor, such as vases or plastic bags, to prevent the robot vacuum from being obstructed or bumping into them and causing damage.
- Do not place children, pets, or any item on top of the robot vacuum while it is stationary or moving.
- Do not use the mopping function on the carpet. The carpet can be cleaned under the vacuuming mode.
- Do not allow the robot vacuum to pick up hard or sharp objects such as building materials, glass, or nails.

- Do not spray any liquid into the robot vacuum .
- Make sure the dust compartment is thoroughly dry before its reinstalling.
- Do not place the robot vacuum upside down.
- Only use this product as directed in the user manual. Users are responsible for any loss or damage arising from improper use of this product.
- For detailed e-manual, please go to www.mi.com/global/service/userguide

Batteries and Charging

- **WARNING:** Only use the supply unit provided with this appliance.
- **WARNING:** For the purposes of recharging the battery, only use the detachable supply unit provided with this appliance.
- The appliance is only to be used with the power supply unit provided with the appliance.
- Do not expose the appliance or battery to excessive temperatures.
- Be aware of the risk of terminals of the battery-operated appliance or battery being short-circuited by metal objects.
- Use only with < AY24CA-AF2000602-EU> supply unit.
- Do not attempt to disassemble, repair, or modify the battery or charging dock on your own.

- Do not place the charging dock near a heat source.
- Do not use a wet cloth or wet hands to wipe or clean the dock's charging contacts.
- If the robot vacuum will not be used for an extended period, fully charge it, then turn it off and store in a cool, dry place. Recharge the robot vacuum at least once every 3 months to avoid over-discharging the battery.
- The lithium-ion battery pack contains substances that are hazardous to the environment. Before disposing of the robot vacuum, please first remove the battery pack, then discard, or recycle it in accordance with local laws and regulations of the country or region it is used in.
- The battery must be removed from the appliance before it is scrapped.
- The appliance must be disconnected from the supply mains when removing the battery.
- The battery is to be disposed of safely.
- Do not damage the battery when removing it to avoid short circuits or liquid leakage. If the battery leaks, keep the fluid from touching your skin or clothes, and wipe it away immediately with a dry cloth. Then send the battery to an appropriate recycling facility or the designated after-sales service team to properly dispose of it.

- When removing the batteries from the product, it is better to use up the batteries and make sure your product is disconnected from power.
 - 1). Uninstall the screw on the bottom, then remove the cover.
 - 2). Unplug the battery connector, then remove the batteries. Do not damage the battery case to avoid any risk of injuries.
 - 3). Return the batteries to a professional recycling organization.

Product Overview

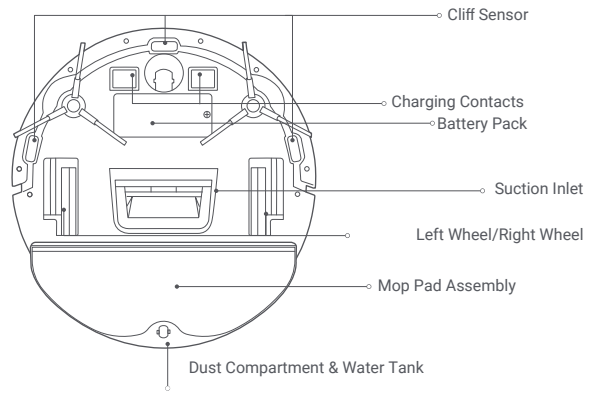
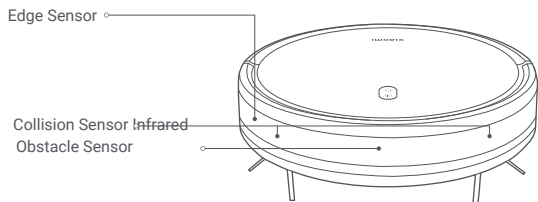
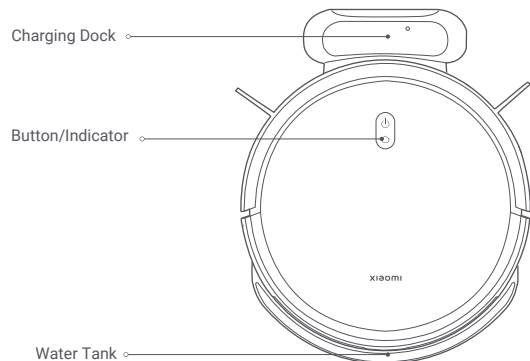

- Press and hold for 3 seconds to turn on or off
- Press to start or pause cleaning
- Press to start or stop docking when on standby
- Press to pause cleaning

Indicator Status Descriptions

White	Turned on/Working normally/Charging completed/Standby
Breathing white	Charging(battery level $\geq 30\%$)/Turning on
Blinking white	Returning to charge/Resetting system
Off	Turned off/In sleep
Yellow	Wi-Fi disconnected
Blinking yellow	Resetting Wi-Fi/Error
Blinking blue	Updating firmware/Connecting to the network

Before Use

Removal and Installation

Please remove the protective strips from both sides of the robot vacuum.

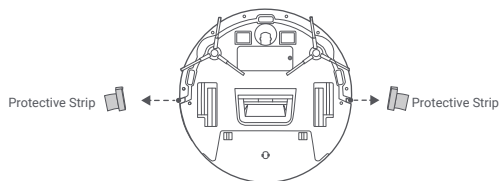

Charging

Remove the protective film from the charging dock. Place the charging dock against a wall and connect it to the power. Then place the robot vacuum onto the charging dock to charge.

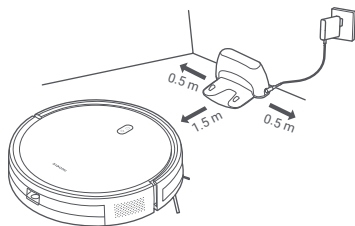

CAUTIONS:

- Do not place the charging dock in an area with direct sunlight.
- Please ensure that no items are placed within 0.5 m on the left and right sides and within 1.5 m in front of the charging dock.
- It is recommended to fully charge the robot vacuum before using it for the first time to maintain its optimal battery performance and maximize battery life.
- The robot vacuum will turn on automatically when it is on the charging dock, and cannot be turned off while charging.

Connecting with Mi Home/ Xiaomi Home App

This product works with the Mi Home/Xiaomi Home app*. Use the Mi Home/Xiaomi Home app to control your device, and to interact with other smart home devices.

Scan the QR code to download and install the app. You will be directed to the connection setup page if the app is installed already. Or search "Mi Home/Xiaomi Home" in the app store to download and install it.



D515505B



Open Mi Home/Xiaomi Home app, tap "+" on the upper right, and then follow prompts to add your device.

* The app is referred to as Xiaomi Home app in Europe (except for Russia). The name of the app displayed on your device should be taken as the default.

Note:

- The version of the app might have been updated, please follow the instructions based on the current app version.

Resetting Wi-Fi

While the robot vacuum is turned on, press and hold the buttons  and  for seven seconds. The Wi-Fi is successfully reset when you hear a voice prompt.

Resetting System

Press and hold the button  for 7 seconds until you hear a beep. Then press and hold the same button for 7 seconds until you hear three beeps, and the robot vacuum restarts. Simultaneously, settings such as network connection and scheduled cleanup are cleared up.

How to Use

Start Vacuuming & Mopping

1. Take out the water tank. Open the plug, and fill the tank up with clean water. Then insert the plug back.

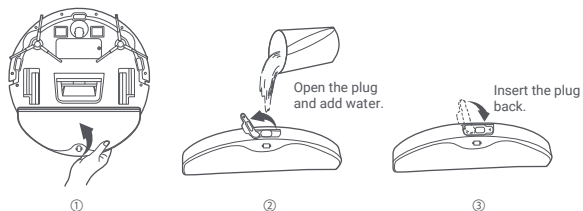

CAUTIONS:

- Do not add any substances other than clean water.
- The functions of robot vacuums are tested before leaving the factory, so there may be some water residues in the robot vacuum. This is normal.

2. Before using the vacuuming & mopping function, wet and wring out the mop pad first. Then insert the mop pad into the groove at the bottom of the water tank, and attach the mop pad firmly to the velcro on the water tank. Once the mop pad is installed, align and insert the clips on the water tank into the slots on the dust compartment. The water tank is secured in place when you hear a click.

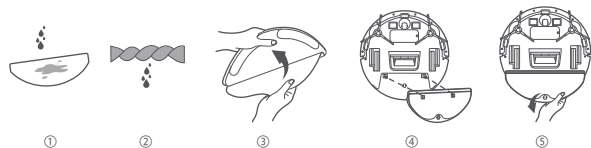

3. Press the button  to vacuum and mop after completing the installation.

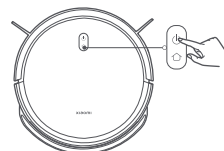

4. After a vacuuming & mopping task is completed, empty any remaining water out of the water tank in a timely manner. Then clean and air-dry the mop pad to prevent odor and mildew.



Note: The water tank and mop pad can be omitted if only the vacuuming function is used.

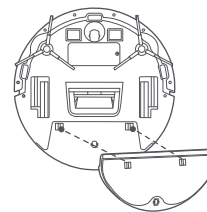

Pausing

When the robot vacuum is running, press any button to pause. Press the button  to resume cleaning.

Note: The robot vacuum will enter sleep mode after being paused or in standby mode for ten minutes. Press any button to wake it up.

Cleaning the Dust Compartment

Press the dust compartment release button to remove the dust compartment, and open it to empty the contents.



Note: Wipe the dust compartment dry after washing. Do not expose it to direct sunlight for a long time.



Adding Water or Cleaning the Mop

Press any button to pause the robot vacuum. Take out the water tank to add water or clean the mop pad, and then put the water tank and dust compartment back. Press the button  to resume vacuuming and mopping.

Docking & Charging

When the robot vacuum is working, press the button  to pause the task, and press the button  again to send the robot vacuum to return to the dock to charge.

When the robot vacuum is in standby mode and not connected to the charging dock, press the button  to send the robot vacuum to return to the dock to charge. When a task is complete or the battery is too low, the robot vacuum will automatically return to the dock to charge.

DND Mode

In the do not disturb (DND) mode, the robot vacuum does not perform scheduled cleanups, and the indicator turns off after one minute of charging. The DND mode can be enabled or disabled in the app.

Note: For more functions, please go to the app.

Note: When using the robot vacuum for the first time, it is recommended to follow the robot vacuum and remove any obstacles on the ground. If the robot vacuum may get stuck or scratch the surface of the furniture in some areas, you can set physical barriers to prevent the robot vacuum from entering those areas.

Care & Maintenance

Side Brush

1. Use a screwdriver to remove the side brushes.

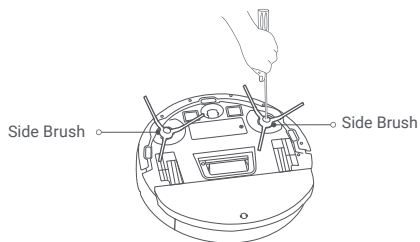

2. Use a cleaning brush to clean the side brushes.



Cut the hair



Remove dirt and debris

Notes:

- Please refer to the details on the label of the water tank and dust compartment for regular cleaning.
- It is recommended to clean the sensors and charging contacts with a cloth every three months.
- Refer to the table below for maintenance and replacement to ensure effective cleaning.

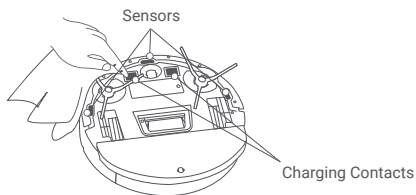

Components	Maintenance Frequency	Replacement Frequency
Side brush	Every two weeks	Every 3–6 months
Filter	Weekly	Every 3–6 months
Mop pad	After each use	Every 3–6 months (or upon worn)

Specifications

Robot Vacuum

Name	Robotic Vacuum Cleaner
Model	C108
Rated Voltage	14.4 V ⁼⁼⁼
Rated Power	25 W
Charging Voltage	20 V ⁼⁼⁼
Item Dimensions	φ 300 × 70 mm
Battery Capacity	2500 mAh (rated capacity) 2600 mAh (nominal capacity)
Net Weight	2.6 kg
Wireless Connectivity	Wi-Fi IEEE 802.11b/g/n 2.4 GHz BLE5.0
Operating Frequency	2402–2480 MHz
Maximum Output Power	< 20 dBm

Under normal use of condition, this equipment should be kept a separation distance of at least 20 cm between the antenna and the body of the user.

Charging Dock

Model	CDZC108
Rated Input	20 V ⁼⁼⁼ 0.6 A
Rated Output	20 V ⁼⁼⁼ 0.6 A
Item Dimensions	170 × 134 × 82.5 mm

Power Adapter

Information Published	Value and Precision	Unit
Manufacturer	Dongguan AOYUAN Electronics Technology Co., Ltd.	-
Model Identifier	AY24CA-AF2000602-EU	-
Input Voltage	100–240	V~
Input AC Frequency	50/60	Hz
Output Voltage	20.0	V ⁼⁼⁼
Output Current	0.6	A
Output Power	12.0	W
Average Active Efficiency	82.96	%
No-load Power Consumption	0.10	W

Regulatory Compliance Information

EU Declaration of Conformity



Hereby, Xiaomi Communications Co., Ltd. declares that the radio equipment type C108 is in compliance with Directive 2014/53/EU. The full text of the EU declaration of conformity is available at the following internet address:
<http://www.mi.com/global/service/support/declaration.html>

WEEE Disposal and Recycling Information



All products bearing this symbol are waste electrical and electronic equipment (WEEE as in directive 2012/19/EU) which should not be mixed with unsorted household waste. Instead, you should protect human health and the environment by handing over your waste equipment to a designated collection point for the recycling of waste electrical and electronic equipment, appointed by the government or local authorities. Correct disposal and recycling will help prevent potential negative consequences to the environment and human health. Please contact the installer or local authorities for more information about the location as well as terms and conditions of such collection points.

WARRANTY NOTICE

THIS WARRANTY GIVES YOU SPECIFIC RIGHTS, AND YOU MAY HAVE OTHER RIGHTS CONVEYED BY LAWS OF YOUR COUNTRY, PROVINCE OR STATE. INDEED, IN SOME COUNTRIES, PROVINCES OR STATES, CONSUMER LAW MAY IMPOSE A MINIMUM WARRANTY PERIOD. OTHER THAN AS PERMITTED BY LAW, XIAOMI DOES NOT EXCLUDE, LIMIT OR SUSPEND OTHER RIGHTS YOU MAY HAVE. FOR A FULL UNDERSTANDING OF YOUR RIGHTS WE INVITE YOU TO CONSULT THE LAWS OF YOUR COUNTRY, PROVINCE OR STATE.

1. LIMITED PRODUCT WARRANTY

XIAOMI warrants that the Products are free from defects in materials and workmanship under normal use and use in accordance with the respective Product user manual, during the Warranty Period.

The duration and conditions related to the legal warranties are provided by respective local laws. For more information about the consumer warranty benefits, please refer to Xiaomi's official website <https://www.mi.com/global/support/warranty>.

Xiaomi warrants to the original purchaser that its Xiaomi Product will be free from defects in materials and workmanship under normal use in the period mentioned above.

Xiaomi does not guarantee that the operation of the Product will be uninterrupted or error free.

Xiaomi is not liable for damages arising from non-compliance with the instructions related to the use of the Product.

2. REMEDIES

If a hardware defect is found and a valid claim is received by Xiaomi within the Warranty Period, Xiaomi will either (1) repair the product at no charge, (2) replace the product, or (3) refund the Product, excluding potential shipping costs.

3. HOW TO OBTAIN WARRANTY SERVICE

To obtain warranty service, you must deliver the Product, in its original packaging or similar packaging providing an equal degree of Product protection, to the address specified by Xiaomi. Except to the extent prohibited by applicable law, Xiaomi may require you to present proofs or proof of purchase and / or comply with registration requirements before receiving warranty service.

4. EXCLUSIONS AND LIMITATIONS

Unless otherwise stipulated by Xiaomi, this Limited Warranty applies only to the Product manufactured by or for Xiaomi and identifiable by the trademarks, trade name or "Xiaomi" or "Mi" logo.

The Limited Warranty does not apply to any (a) Damage due to acts of nature or God, for example, lightning strikes, tornadoes, flood, fire, earthquake or other external causes; (b) Negligence; (c) Commercial use; (d) Alterations or modifications to any part of the Product; (e) Damage caused by use with non-Xiaomi products; (f) Damage caused by accident, abuse or misuse; (g) Damage caused by operating the Product outside the permitted or intended uses described by Xiaomi or with improper voltage or power supply; or (h) Damage caused by service (including upgrades and expansions) performed by anyone who is not a representative of Xiaomi.

It is your responsibility to backup any data, software, or other materials you may have stored or preserved on the product. It is likely that the data, software or other materials in the equipment will be lost or reformatted during the service process, Xiaomi is not responsible for such damage or loss.

No Xiaomi reseller, agent, or employee is authorized to make any modification, extension, or addition to this Limited Warranty. If any term is held to be illegal or unenforceable, the legality or enforceability of the remaining terms shall not be affected or impaired.

Except as prohibited by laws or otherwise promised by Xiaomi, the after-sales services shall be limited to the country or region of the original purchase. Products which were not duly imported and/or were not duly manufactured by Xiaomi and/or were not duly acquired from Xiaomi or a Xiaomi's official seller are not covered by the present warranties. As per applicable law you may benefit from warranties from the non-official retailer who sold the product. Therefore, Xiaomi invites you to contact the retailer from whom you purchased the product.

The present warranties do not apply in Hong Kong and Taiwan.

5. IMPLIED WARRANTIES

Except to the extent prohibited by applicable law, all implied warranties (including warranties of merchantability and fitness for a particular purpose) will have a limited duration up to a maximum duration of this limited warranty. Some jurisdictions do not allow limitations on the duration of an implied warranty, so the above limitation will not be applied in these cases.

6. DAMAGE LIMITATION

Except to the extent prohibited by applicable law, Xiaomi shall not be liable for any damages caused by accidents, indirect, special or consequential damages, including but not limited to loss of profits, revenue or data, damages resulting from any breach of express or implied warranty or condition, or under any other legal theory, even if Xiaomi has been informed of the possibility of such damages. Some jurisdictions do not allow the exclusion or limitation of special, indirect, or consequential damages, so the above limitation or exclusion may not apply to you.

7. XIAOMI CONTACTS

For customers, please visit the website:

<https://www.mi.com/global/support/warranty>

The contact person for the after-sale service may be any person in Xiaomi's authorized service network, Xiaomi's authorized distributors or the final vendor who sold the products to you. If in doubt please contact the relevant person as Xiaomi may identify.

Manufactured for: Xiaomi Communications Co., Ltd.
Manufactured by: Shenzhen Silver Star Intelligent Group Co., Ltd.
(a Mi Ecosystem company)
Address: Room 1701, Silver Star Building No.2, No.1301-72, Guanguang Road,
Guanlan Street, Longhua District, Shenzhen, Guangdong, China

For further information, please go to www.mi.com

Made in China

Importer:
Beryko s.r.o.
Pod Vinicemi 931/2, 301 00 Plzeň
www.beryko.cz



For further details, please scan the QR code to obtain the e-manual.

